

ROBOR

Sicherheitskurbel 1,5-20 To. Tragkraft
 Manivelle de sécurité 1,5-20 To. Force

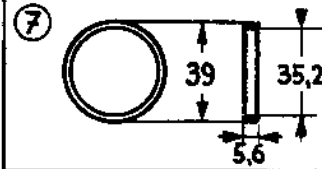

Laufring
 Bague en plast.

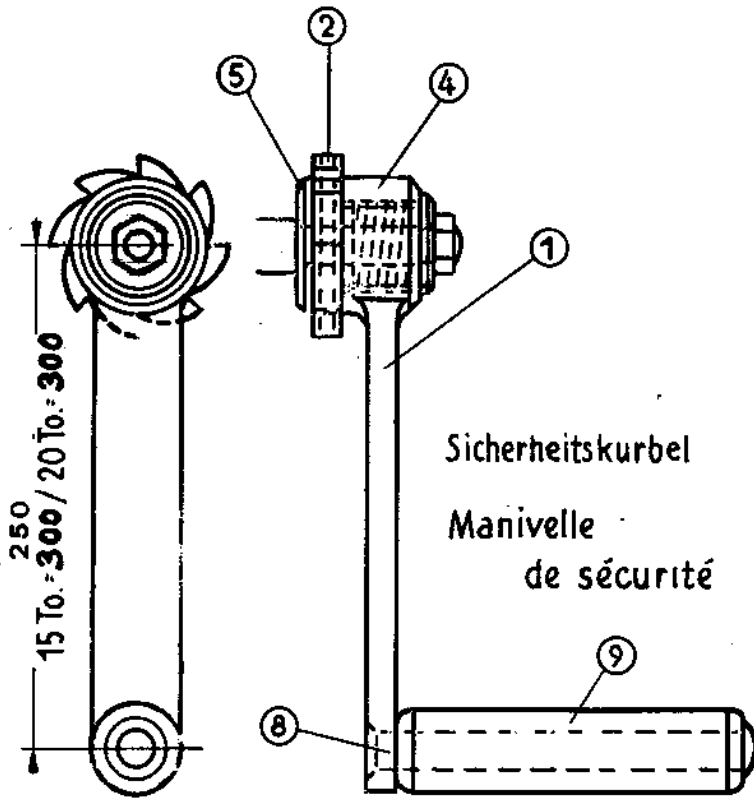

Doppelsperklinke
 Encliquetage

Kurbeltrieb / Engrenage de la manivelle

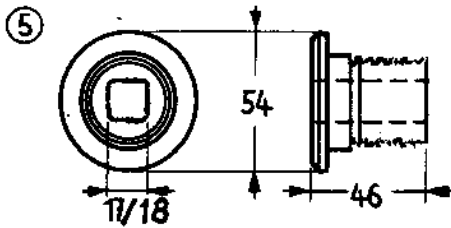
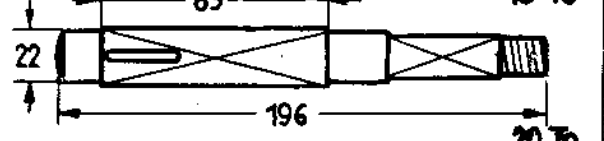
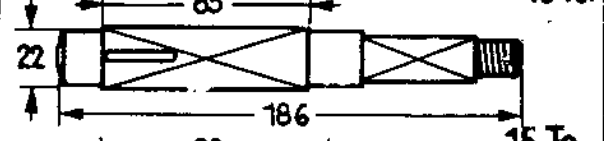
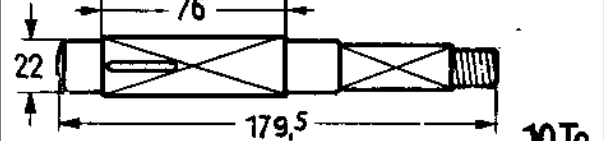
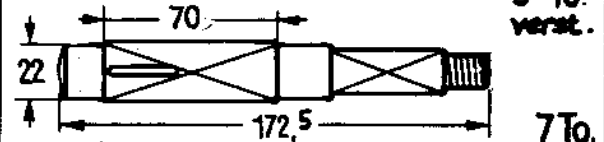
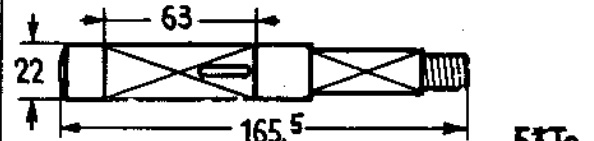
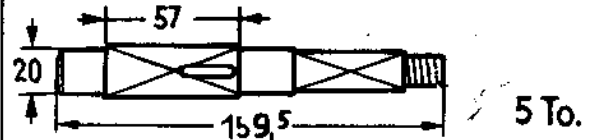
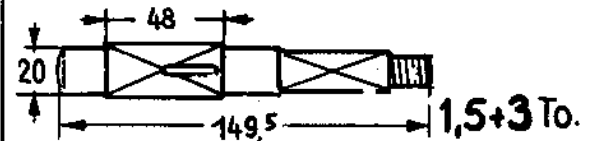

Gewindezapfen
 Raccord filté
 ab 5*^t verstärkt
 4-Kant 18mm

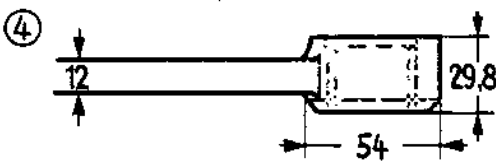

Kurbelaug
 Vis - mètre

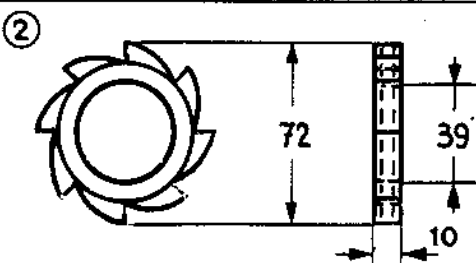

Sperrad
 roue à rochet

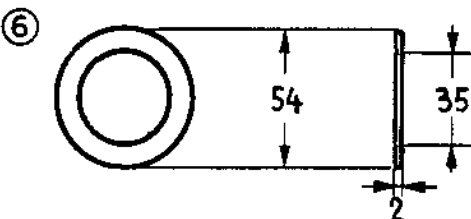

Bremsring
 Bague de
 friction

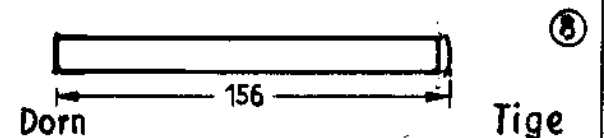

Tige

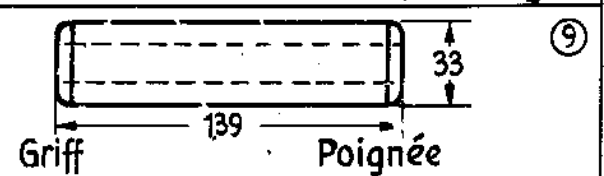

Poignée